



Isolated Mode Antenna Technology

Frank M. Caimi, Ph.D
Mark Montgomery
Paul Tornatta

January 2008

Introduction

iMAT is a new antenna technology that improves antenna gain and receiver sensitivity, significantly enhancing device performance and network capacity in MIMO or related communications systems using multiple antennas. Although it is counterintuitive to think that a single antenna can offer the performance benefits of multiple antennas, the iMAT solution enables a single antenna structure to behave like multiple antennas through the use of multiple feed points. Each feed provides high isolation, low correlation, and high per-feed radiation efficiency without the need to design and place multiple antennas in a small space.

To obtain the benefits of MIMO or diversity communications systems, antennas typically must be properly configured to take advantage of the independent signal paths that can exist in the communications channel environment. [1] With proper design, one antenna's radiation is prevented from traveling into the neighboring antenna and being absorbed by the opposite load circuitry. Typically, a combination of antenna separation and polarization is used to achieve the required signal isolation and independence. However, when the area inside devices is extremely limited, this approach often is not effective in meeting industrial design and performance criteria. As a result, the industry has settled for single antenna solutions or diversity configurations with poorly performing ancillary antennas.

So how did SkyCross achieve the seemingly impossible task of designing a single antenna with multiple feeds? SkyCross realized that different modal excitation of a single radiating structure is possible while maintaining isolation between multiple feeds located on the same structure. Therefore, isolation between the feeds is possible. Also, the antenna pattern produced by each feed can be sufficiently different so signals transmitted or received between the different feed points are essentially independent—a requirement for higher gain diversity systems and high-throughput MIMO communications.

MIMO Metrics and Correlation Coefficient

For a MIMO communications system to fully exploit independence of signal channels, the transmitter and receiver must utilize multiple antennas with prescribed metrics. Metrics for MIMO communications systems have been developed, and many sources exist in the scientific literature. One metric commonly used to measure the potential for an antenna system to produce independent received signals is the antenna pattern correlation coefficient, which is defined by the following equation [2]:

$$\rho_p = \frac{\int_0^{2\pi} \int_0^{\pi/2} A_{12} \sin \theta d\theta d\phi}{\sqrt{\int_0^{2\pi} \int_0^{\pi/2} A_{11} \sin \theta d\theta d\phi} \sqrt{\int_0^{2\pi} \int_0^{\pi/2} A_{22} \sin \theta d\theta d\phi}}$$

where $A_{mn}(\theta, \phi) = X E_{\theta n}(\theta, \phi) E_{\theta n}^*(\theta, \phi) + E_{\phi n}(\theta, \phi) E_{\phi n}^*(\theta, \phi)$
and the cross-polarization power ratio $X = S_\theta / S_\phi$

This equation is specific to a two- antenna system and produces a coefficient whose magnitude is normalized to unity based on electric field components measured in a 3-D antenna range. If the antennas produce completely orthogonal patterns, the coefficient magnitude is zero. Conversely, two antennas with the same field component pattern produce a coefficient magnitude equal to one, as shown in Figure 1a. Because MIMO communications systems rely on separate spatio-temporal channels to achieve greater information transfer capacity, it is desirable to establish separate spatial directional response for each antenna to obtain the necessary channel independence. This creates a preference for sufficient pattern independence to produce a correlation coefficient magnitude below a certain threshold. The communications channel itself is also involved in achieving separate or independent spatio-temporal paths, and modifications to Eq 1 for those effects can be included for completeness. [3, 4]

Antenna Coupling or Isolation

The importance of isolation or reduced coupling between multiple feed antennas can't be over emphasized, since energy transmitted from one antenna can be absorbed by neighboring antenna(s). The situation is as shown in Figure 1b.

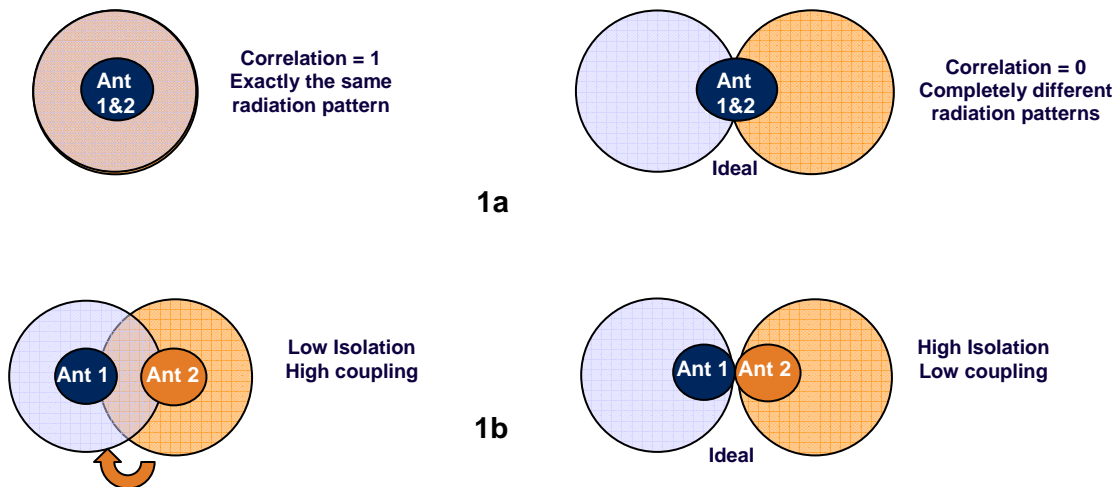

Figure 1. Antennas on the left have coupled near-radiation fields and highly correlated inputs, coupling energy from one into the other. The ideal situation is shown for the antennas at right where little radiation is coupled between antennas, and the correlation coefficient is zero.

Since iMAT provides sufficiently large isolation between feedpoints, the effect of unwanted coupling between antennas becomes negligible. This advantage can improve the radiation efficiency and therefore Total Radiated Power (TRP) by several dB (a factor of 1.5 or more) compared to similar non-iMAT solutions.

Coupling and its effect on antenna efficiency, and ultimately on TRP is illustrated pictorially in Figure 2.

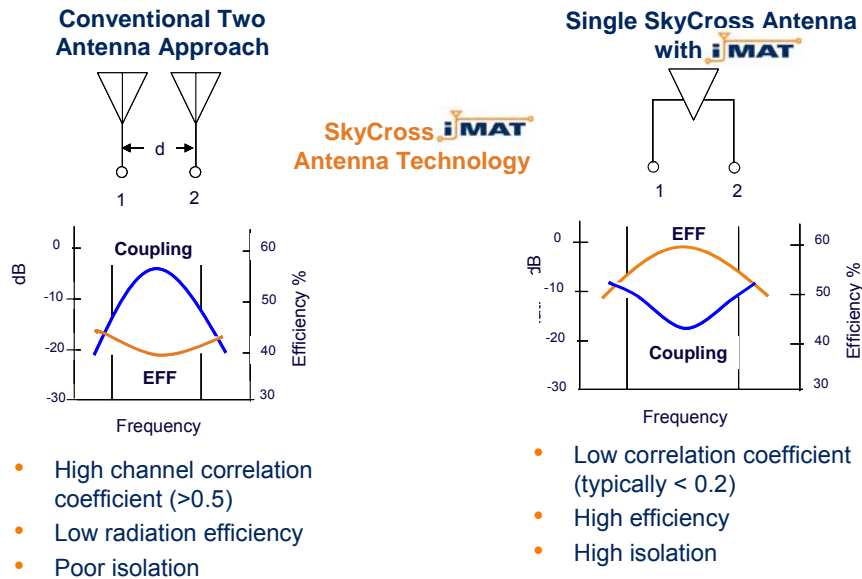

Figure 2. Illustration of the advantages of the iMAT single antenna over multiple individual antennas showing enhanced efficiency and reduced interelement coupling

Currently, iMAT supports legacy networks and is essential for next generation protocols that require diversity or MIMO such as HSxPA, WiMAX, 802.11x, and LTE. iMAT creates a new way to think about creating a diversity or MIMO system. Ultimately, by using the advantages derived from better performing MIMO systems, end users will be able to realize the full potential of their wireless services and demand faster connections at an increasing rate.

iMAT WiMAX/WiFi Technology Example

To illustrate the above effects and the benefit of the iMAT approach, refer to Figure 3 showing an example of a USB antenna application for the 2.4-2.5 GHz band. Shown is a typical USB device consisting of a printed circuit board (PCB) assembly, enclosed in a plastic housing, with USB connector at one end. The space available for the antennas is assumed to be at the opposite end of the PCB. The width of the device is 20 mm and the length and height available for the antennas are 10 mm and 2.5 mm, respectively. The majority of the PCB, between the antennas and the USB connector, is a continuous RF ground.

Three different antenna solutions are shown for comparison. The first consists of two meanderline monopoles in the same form factor as illustrated in Figure 3. The distance from the ground available for the radiator is 10 mm, or $\lambda/12$ in free-space; however, the

monopoles are made an effective $\lambda/4$ length through the use of a meanderline, slow-wave structure. The second case also uses the same meanderline monopoles, but with an added metal shielding strip extending from the PCB ground and between the two monopoles. The third case considers the iMAT solution that includes a similar meanderline loading method for space efficiency, but one that maintains a half-wave equivalent electrical length as a single resonator. The iMAT solution in this case uses a half-wave mode of a specially-shaped element where the location of each feed port is carefully configured to provide the desired isolation.

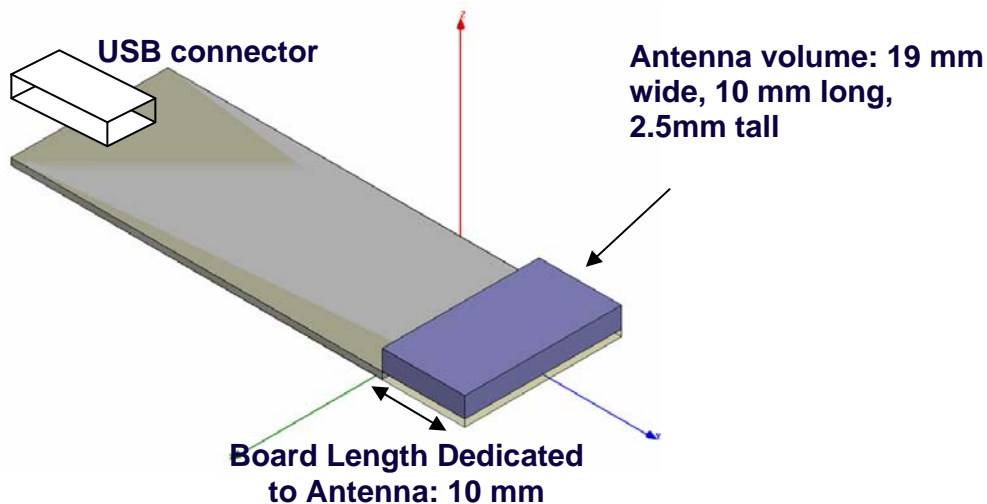
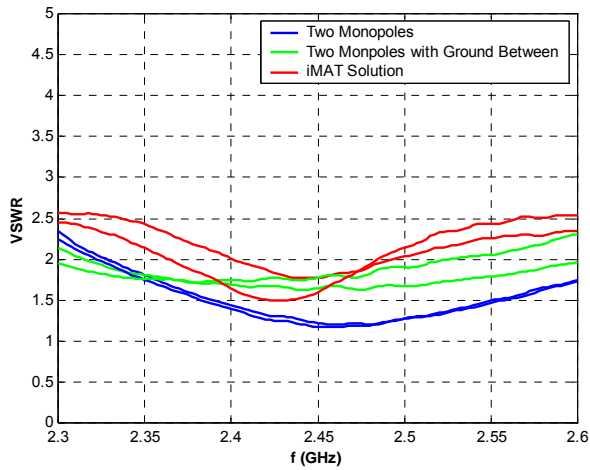

Figure 3. Example WiMAX USB antenna illustrating small antenna volume of 19mm wide by 10mm high and extending away from PCB distal end by 10mm, and measured correlation coefficient less than 0.4 and efficiency of 68 percent for the same antenna [www.skycross.com].

A comparison of measured performance for the three solutions is shown in Figure 4. All three approaches yield good impedance match with a VSWR of 2 or better over the band. (Figure 4a). However, the coupling, (S_{21}) for the monopoles is poor—about -4dB as shown in Figure 4b. The addition of the ground extension between the antennas provides marginal improvement of S_{21} to about -6dB. The iMAT solution has considerably better isolation, with S_{21} values between -10 and -15 dB in the designated band.

The S_{21} value has a direct impact on efficiency due to signal loss to the neighboring antenna and its associated load. Not surprisingly, the iMAT solution shows better efficiency than the other solutions as shown in Figure 4c. Similarly, the iMAT solution produces more diverse antenna patterns as indicated by the graph of antenna-pattern-derived, envelope correlation coefficients, calculated using the following equation and shown in Figure 4d.



4a

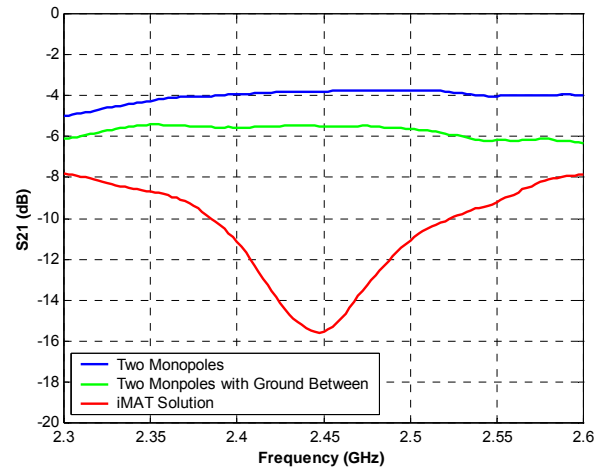

4b

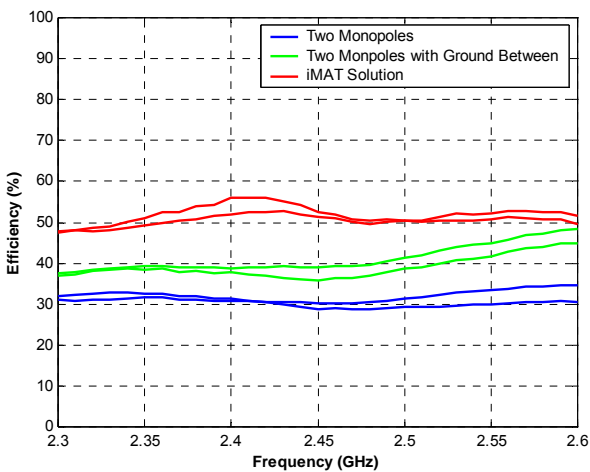

4c

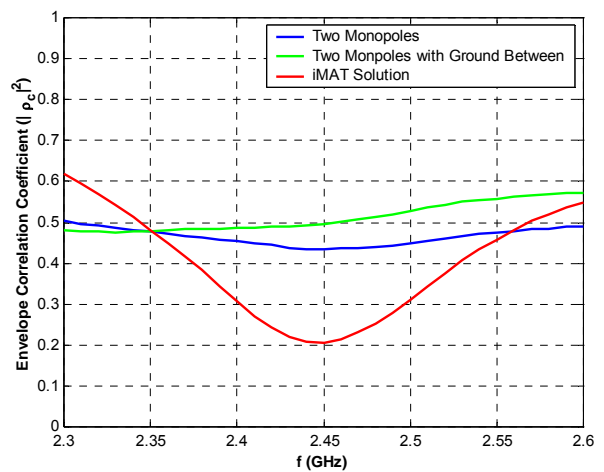

4d

Figure 4. Comparison of (a) VSWR, (b) S_{21} , (c) Radiation Efficiency, and (d) Envelope Correlation Coefficient for 3 cases: two monopoles, two monopoles with ground plane isolation tab, and iMAT antenna showing advantages from the isolated mode methodology.

Although radiation efficiency is improved, an added benefit is the reduced correlation coefficient achievable with iMAT versus close proximity multiple antenna solutions. Correlation coefficients of less than 0.5-0.7 are desirable for MIMO and diversity communications systems. Although achieving these correlation coefficient values is possible with multiple antennas on a given platform, the iMAT solution is ready-made, requiring little additional engineering design. In addition, for those antenna systems not able to achieve low correlation values, the benefits of iMAT include improved system capacity and data rates.

Three Antenna Example for 802.11n:

The 802.11n standard specifies a 3-antenna solution to provide MIMO capability. Generally, three antennas require sufficient spacing to reduce coupling between elements. The iMAT solution is a single antenna solution shown in Figure 5.

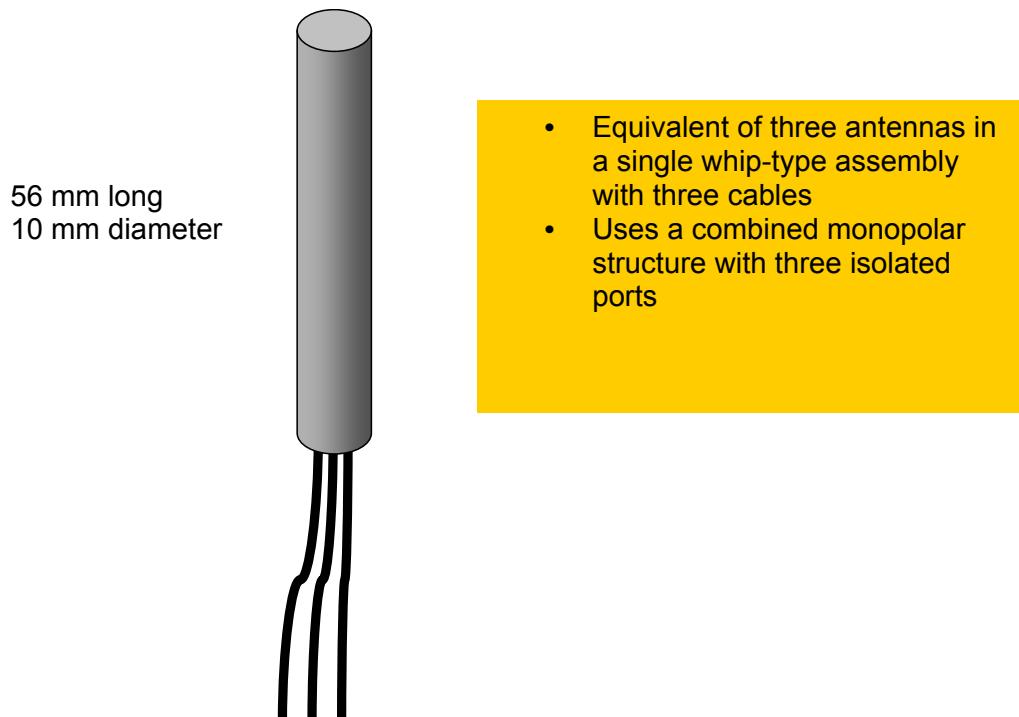
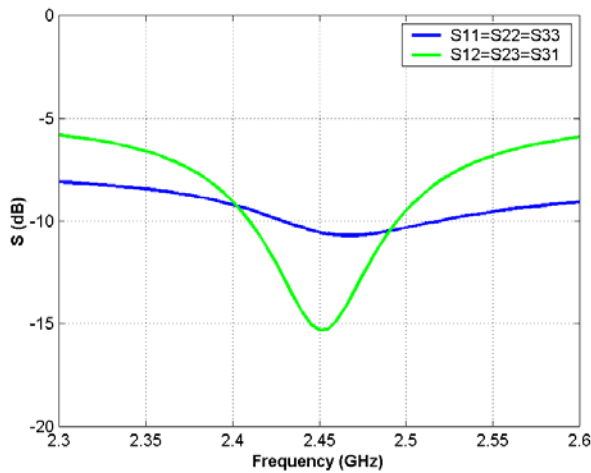

Figure 5. Example 802.11n antenna in a single structure and three separate feed connections using iMAT

The antenna consists of a single radiating structure with separate feed cables. The antenna VSWR and isolation characteristics are shown in Figure 6a. VSWR for each feed is below 2:1 (RL < -10dB), and the isolation between each feed is also nominally -10 dB over the 2.4 to 2.5 GHz band. Unlike most closely spaced antennas, the isolation improves as the frequency is swept through the resonance where the VSWR or return loss is optimized. This is a distinguishing characteristic of the iMAT antenna versus using separate, closely spaced radiators.

Shown in Figure 6b is the radiation efficiency for excitation at only one of the feeds, since each is identical due to the symmetric design of the antenna element. With proper tuning the efficiency exceeds 60 percent across the entire ISM band, as shown.

6a



6b

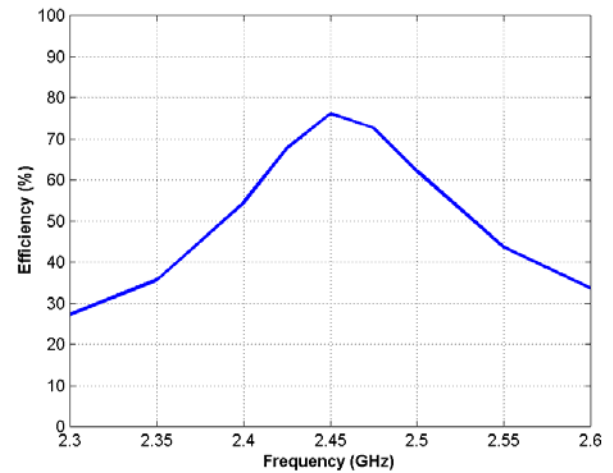

Figure 6. a) Return loss and isolation (dB), and b) radiation efficiency versus frequency for the single element iMAT 802.11n antenna.

Normally, in this frequency regime with 10mm spacing, the isolation would be much less and the efficiency would be substantially reduced from 60 percent.

Another necessary feature of an antenna designed for a MIMO application is a low correlation coefficient. To see how this is achieved, in Figure 7a we show the far-field patterns produced by two of the three elements. Each feed of the antenna produces a cardioid pattern that is essentially different from the pattern produced by the adjacent feed. The net result is a low computed correlation coefficient using Equation 1. Values less than 0.2 are achievable as shown in Figure 7b over the operating band where computations were performed on both the two- and three-dimensional far-field patterns produced by the antenna. In both cases these are more than sufficient for any diversity or MIMO application.

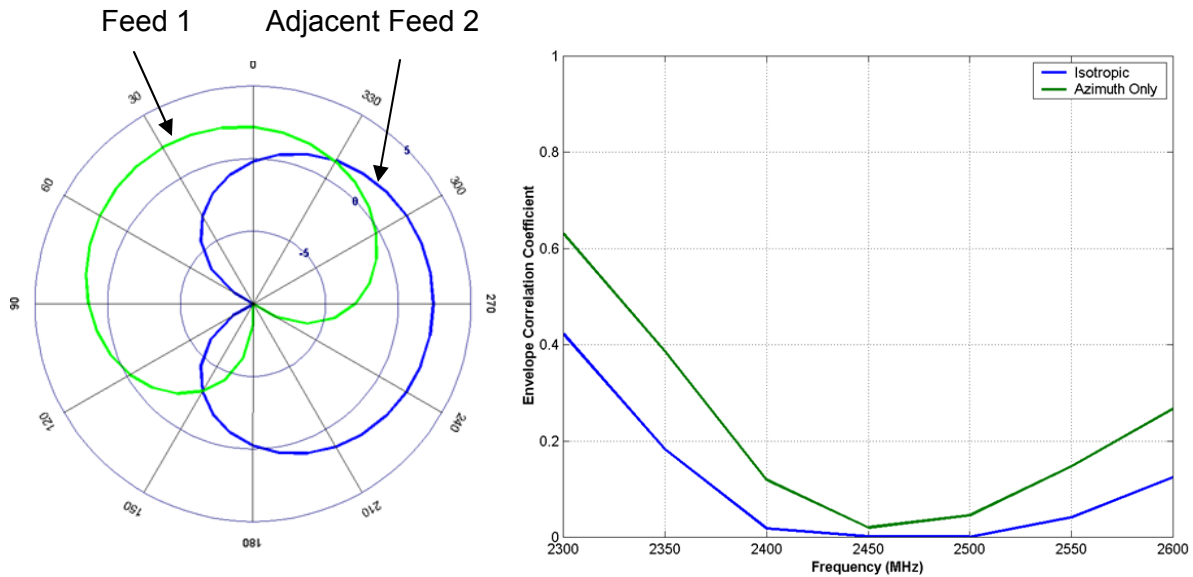

Figure 7. Pattern independence and low correlation coefficient needed for MIMO and Diversity applications are benefits of the 802.11n iMAT implementation. a) Azimuthal far-field pattern for different feeds showing independence, and b) Envelope correlation coefficient take for either 3D pattern (blue) or azimuthal pattern (green).

In summary, these examples show that iMAT makes diversity or MIMO systems possible, even in instances where the industry long ago decided such implementation was impossible. SkyCross has discovered a way to reap all the benefits of optimized multiple antennas—multiple radiation patterns and improved link performance gain leading to faster data rates, increased network capacity, and better reliability—in one small antenna.

End users want trendy devices with lots of features that perform well, and they want their devices to hold a charge for weeks. iMAT optimizes antennas to deliver a satisfying user experience. Higher gain and efficiency provide users with better signal strength, even when the nearest tower or base unit is far away. This capability reduces dropped calls, increases range, and enables faster data transfer for high-definition video, music, etc.

References:

1. Parson, S.D., "*The Mobile Radio Propagation Channel*," 2nd edition, Wiley, 2000
2. [S. Blanch](#), [J. Romeu](#), and [I. Corbella](#), "Exact representation of antenna system diversity performance from input parameter description," *Electronics Letters*, 1 May 2003, Volume 39, Issue 9, p. 705-707
3. Breit, G. and E. Ozaki, "Phone Level Radiated Test Methodologies for Multi-Mode, Multi-Band Systems," IWPC Transactions "Handset Antenna Technologies for MultiMode, Multi-Band, Durham, NC, Jan 2007.
4. Kalliola, et al., "Angular Power Distribution and Mean Effective Gain of Mobile Antennas in Different Propagation Environments," *IEEE Trans, Vehic. Tech.* v. 51, no. 5, Sept. 2002.
5. Skycross, Inc, www.skycross.com, WiMAX Antenna Internal Report, Jan. 2008.